



BEAUTIFUL **LIVING**

transforming conservatories into an all year round living space

Welcome

When you specify a SupaLite Roof, you will benefit from in depth research and enormous investments that have arrived at the perfect replacement roof for your conservatory.

The SupaLite roof has undergone exhaustive testing, design and re-design to arrive at a product for every conservatory roof design and configuration. With changes to Building Regulations in September 2010 it is now possible to specify a tiled, solid and lightweight roof for your conservatory.

Our aim is to ensure that you specify the correct solution for your conservatory and do not breach Building Regulations by choosing the wrong roof or modifications to your existing roof that will not meet Building Regulations and will therefore be potentially unsafe and be a waste of your time and money.



The SupaLite roof is a revolution in the conservatory industry. It is providing owners of tired old and energy inefficient conservatories with a radical solution to extreme temperature fluctuations.

Join the revolution and insist on a SupaLite Conservatory Roof.

- 02** WHY SUPALITE
- 03** THE BENEFITS
- 04** REGULATIONS
- 06** SUPALITE ROOF
- 09** SUPALITE PLUS
- 09** ECO ROOF
- 10** ORANGERIES
- 12** MONOROOF
- 13** FEEDBACK
- 14** INVITING INTERIORS
- 15** BEAUTIFUL EXTERIORS
- 16** FINISHING TOUCHES
- 17** ROOF COVERINGS

WHY SUPALITE

Quite simply, the SupaLite Tiled Conservatory is the tried and tested roofing system to provide you with a certified, safe and energy efficient roof for your conservatory.

When you specify your new SupaLite roof you are set to benefit from a highly energy efficient roofing system that has been specifically designed and tested to create you a dream living space.

When SupaLite roofs are installed, many customers remodel their conservatories internally to give the feel of a true lounge. This can be achieved by plastering internal walls and adding decoration and furnishings more akin to lounge furniture rather than cane furniture more traditionally used in conservatories. This can be done with peace of mind knowing that you will not be sitting on cold leather or damp cold fabric furnishings anymore.

With the SupaLite roofing systems unique design features, all configurations of roofs can be achieved. You will be delighted at just how much the roof insulates your conservatory. Gone will be months of extreme cold and heat variations.

With a choice of internal finishing methods, you can choose to specify a vaulted ceiling or a lowered 2400mm flat ceiling with integral lighting. We also install if specified a 350mm lighting pelmet around the internal ring beam which can additionally incorporate dimmable down lighting or even surround sound speakers for your audio system to connect to.

The transformation you will benefit from is astounding. Not only will you greatly reduce the energy costs of retaining a moderated living temperature in your conservatory, but you will also have more occasions for spending time in your conservatory and fall in love with it again.



THE BENEFITS

SupaLite gives an incredible **u-value of 0.18** (0.15 for the Scottish market with SupaLite Plus) that meets total building regulations

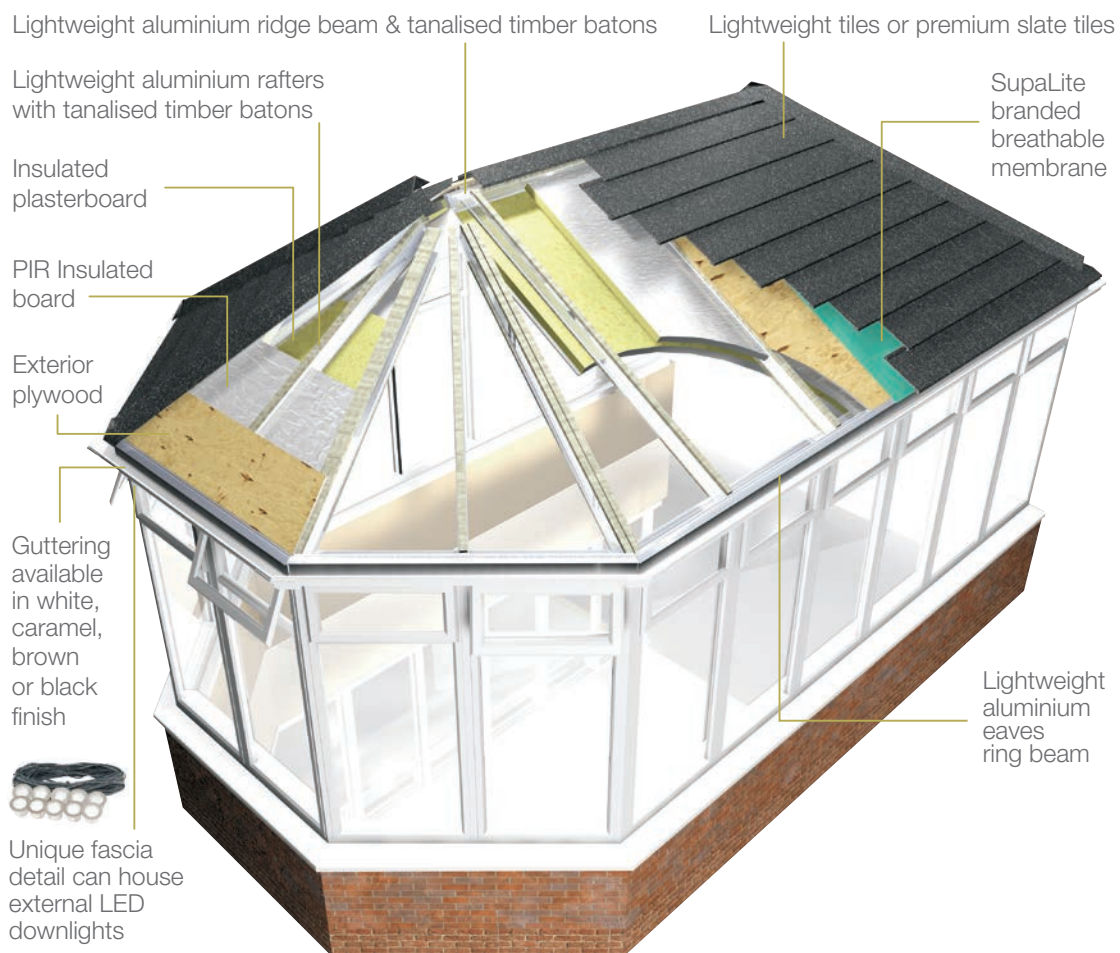

- Lightweight aluminium fully structural frame with frame connector system for when new windows or doors are to be fitted to a new or existing building.
- Choice of tile and slate colours, all tiles are tried and tested for many years in USA, Canada and Australia, giving you total peace of mind in extreme weather conditions.
- 25 year guarantee on tiles with a life expectancy of over 50 years.
- Large roof vents are available to allow in maximum light.
- Full range of colour matching fascias, soffits and gutters to suit your choice of windows.
- Choice of internal ceiling finishes (plaster or tongue & groove timber effects).
- Easy to install to existing conservatory frames.

REGULATIONS

The **LABC** (Local Authority Building Control) have taken the step of producing a guide for you the householder to read thus ensuring that you specify a replacement roof designed, tested and warranted for the purpose of insulating and improving your conservatory. The company offering you a replacement or new roof should offer a copy of this document to you.

It should be pointed out that it is you the homeowner that is responsible to ensure that the work carried out and materials used in your roof comply with the law and can be evidenced with valid test data produced by an authoritative body and experts in their field.

There should be no short cuts in making sure your roof has the right credentials, which include test data and warranty, and carries LABC certification to validate it. If you do not choose the correct solution, apart from being potentially structurally unsafe, you may find that you have problems when you come to sell your home and your selling agent is required to generate your home Energy Performance Certificate which is a mandatory document for the sale and resale of homes in the UK since 1st August 2007.

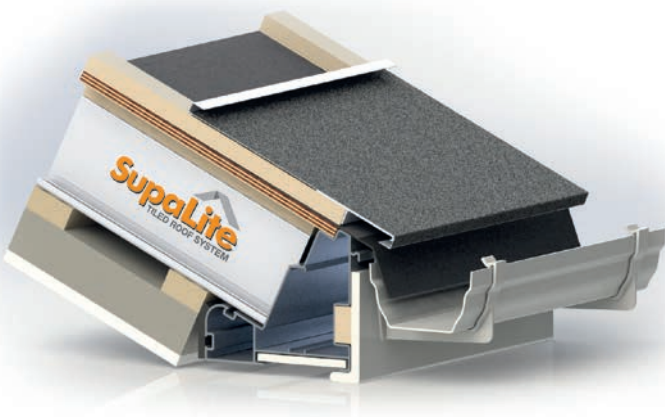

The predominant reason for specifying a roof designed from the start to be a highly insulated roof and structurally sound and tested is simple. Your roof and your conservatory as a whole has to withstand years of extreme UK weather conditions ranging from extreme heat, cold, wind and probably most of all snow.

In recent years the UK weather patterns are becoming more extreme. It is not unheard of in the UK for temperatures to fall and homeowners to be subjected to heavy snowfall in a short period of time.



You only have to imagine 30cm of snow falling on top of your conservatory that does not melt due to the high insulation properties of the materials used in a SupaLite Tiled Conservatory Roof. It is not unusual for badly fitted and specified conservatory roofs to invert due to the sheer weight of the roof and snow combining and the frames below spreading due to inadequate reinforcing and inadequate fastenings being used when the conservatory was manufactured and installed. In these circumstances your home insurer may fail to cover your conservatory due to the absence of a warranty or test data from your supplier.

In the LABC Householders guide to re-roofing conservatories and porches, there is also a mention of condensation that "there is also a potential to introduce a condensation problem that will inevitably occur if plasterboard is applied to the underside of the existing roof with little or no insulation above it" in simple terms, if little or no insulation is offered, there will be cold bridging from the outside climate to the inside plasterboards that will show as lines of beaded condensation where the roof rafters are fitted, due to warm, moist air being attracted to the coldest parts of the roof.

JHAI Ltd is a Corporate Approved Inspector licensed by the Construction Industry Council to give certified Building Regulations Approval as an alternative to Local Authority Building Control whilst maintaining the same high standards.



*"Everything you need to know
to stay on the right side of
building control"*



SUPALITE ROOF



"Every SupaLite roof is tailor made for each individual conservatory. They are precision surveyed and factory made ensuring a perfect fit to every size and configuration of roof"

"When replacing your old conservatory roof with a SupaLite roof, you are immediately reducing your properties carbon footprint and reducing your energy costs"



The difference it made by fitting a SupaLite roof is outstanding. The benefits will be immediate and will be enjoyed 365-days of the year.

"We love our new SupaLite Roof. It has totally changed our tired old conservatory into a beautiful new Sun Porch where we can sit, relax and enjoy the indoor outdoor feel again without all the drawbacks of our old conservatory roof"

"By fitting a SupaLite roof we have reduced glare, rain and ambient external noise, maintenance, but above all else it has eliminated the extreme temperature fluctuations of the UK seasonal weather"

When replacing your old conservatory roof with a SupaLite roof you are immediately reducing your properties carbon footprint and reducing your energy costs.

"We had a few doubts about the difference the SupaLite roof would make to our conservatory. We were wrong and can give our feedback to SupaLite; it is the best thing we have bought for a very long time. It really does offer all the benefits we were promised"

"I wish the SupaLite roof had been fitted when we first bought our conservatory. It would have made a huge difference to the amount of use our family could have had during the past 15 years"

"Our SupaLite roof has created a perfect additional lounge and space for our teenage children to study and spend time with their friends"

Fall in love with your conservatory again by fitting a SupaLite roof.

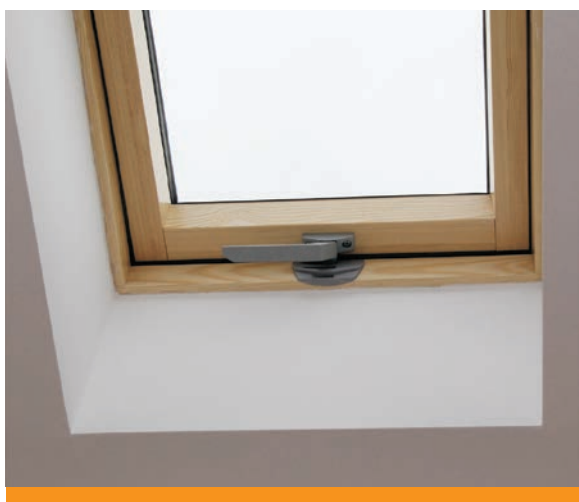

SUPALITE ROOF



After



Before



SUPALITE +PLUS

Specifically engineered for the Scottish market

The SupaLite +PLUS specification of roof has been specifically tailored to meet the building control standards of the Scottish market.

U-Value 0.15 W/m².K Scottish Building Control Approved

The structure of the SupaLite +PLUS roof is the same highly acclaimed and popular design as our standard roof, allowing you to enjoy all of the SupaLite benefits.

The additional rating has been achieved by the use of sarking boards and an extra insulated panel.



ECO ROOF

A compact design with minimal soffit detail

Our SupaLite ECO Roof has been specifically developed to fill a void in the market for a cost effective solution to a solid conservatory roof conversion where minimal overhang is key.

In some situations, the conservatory is positioned tight up to a neighbouring property or boundary that limits the amount of overhang available. Our standard SupaLite Roof is designed to incorporate a soffit detail, just like a conventional roof or extension, this may in some circumstances project over a boundary.

Our ECO Roof design does away with the soffit detail and follows the contours of more like a polycarbonate conservatory roof. There is also a slight cost saving to be enjoyed by this design.



SUPALITE ORANGERIES



A SupaLite Orangery is the most modern and efficient way for you to enjoy both the indoors and outdoors whilst retaining a light and warm conservatory.

Perfect for retro-fit or new-build the new Orangery comes with all the outstanding features the industry has come to expect from Supalite, aesthetic appeal, superb technical capabilities, excellent thermal efficiency and of course with ease of installation.

The arrival the Orangery roof is a natural progression for us building on the incredible success of our Supalite tiled roof range.

It is the next product in our portfolio, but by no means the last. We believe that our new Orangery roof is perfect for today's market.

It is of course ideal for new-build applications, but it is equally suitable for the replacement roof market and is designed to enable the replacement of the flat roofs which are installed on so many existing orangeries.

Being able to replace a flat roof with a pitched roof will take away so many potential problems and of course it then brings with it the other advantages of the vaulted ceiling internally and the use of composite slates externally give it an outstanding appearance inside and out.



"Convert your old conservatory into a new SupaLite Orangery"



MONOROOF



The Lean-To style roof system that embraces all of the luxuries of an orangery with the superior insulating benefits of the much trusted SupaLite Lightweight Replacement Roof.



ExtraLight Roof Tiles as standard

Rolled Aluminium Panels optional

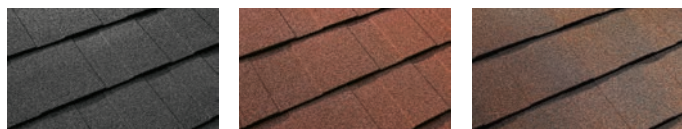

Charcoal

Ember

Walnut

Zinc

Dark Zinc

Copper

Copper Oxide

The popular lean-to roof has seen little in the way of design changes or innovations over the years. Widely used for home extensions and conservatories in the UK, the lean-to roof has been overlooked by the industry in general.

***"with its part glazed and part tiled design,
it is a step forward for the Lean-to roof"***

Based upon the success of the ever popular SupaLite Roof System, the SupaLite MonoRoof, with its part glazed and part tiled design, it is a step forward for the Lean-to roof, creating a light, appealing and modern roof space that is highly insulated for winter warmth and cool summer days.

FEEDBACK



The SupaLite roof is the dawn of a new era in the conservatory market and will benefit 1000's of customers for generations to come.

"The installation was quick and the workmen were immaculately tidy. We expected days of disruption but we were pleasantly surprised at how straight forward it was to replace our old roof with the new one"

"We were never entirely happy with our conservatory and there was always a reason why we did not enjoy it. Now we can use it whenever we like and it feels so comfortable to spend time in"

"We have completely remodelled our conservatory by fitting new bi-folding doors and a SupaLite roof to create an open air dining room. This is what we always wanted. Its perfect"

"When deciding to purchase our new SupaLite roof we were concerned that we would lose light into our lounge and kitchen. There is virtually no difference at all thanks to the opening roof lights fitted into the roof"

"As soon as our neighbour had their roof fitted, we wanted a SupaLite roof fitting to our conservatory too. I imagine some of our friends will have their roofs replaced by SupaLite when they see just how much it has transformed ours"

"It has made such a difference to the atmosphere in our conservatory. The sound of everything has changed and it feels just like an extension instead of a conservatory"

"We were uncertain whether a conservatory as large as our could have a SupaLite roof fitted but it could. We chose a flat ceiling and it is now no different to sitting in a lounge. I can't believe the difference"

"What a difference the SupaLite roof has made to a tired old conservatory. We were contemplating having it removed and building an extension instead. This has saved us a lot of money and the disruption of having builders at our home"



INVITING INTERIORS

VAULTED CEILINGS

There are so many improvements to make at the time you are choosing your SupaLite roof both internally and externally.

For many conservatory owners the internal aspect is the part of the SupaLite roof conversion they look forward to. The look and feel of a vaulted and plaster finished ceiling with recessed LED or GU spotlights fitted.

By opting for a spacious vaulted ceiling, your transformed conservatory will have the feeling of a modern great room so common in property extensions today. It will pleasantly surprise you how different and permanent feeling your SupaLite roof conversion will make to your conservatory.



BEAUTIFUL EXTERIORS

UNIQUE FEATURES

When choosing a SupaLite replacement or new conservatory roof, you will be choosing the only lightweight tiled roof system available with a structurally built in matching soffit and fascia system. This was a fundamental design feature. This achieves the look of a real extension to your home and can even be fitted with LED patio lighting for security and added style to match your garden lighting. This optional lighting will most definitely add the wow factor to your property.

"We love the LED integrated lighting in our roof, particularly the LED lights outside, they really add something special to our conservatory"

"Our old glass roof was never clean and the conservatory felt to much like a glass box. The SupaLite roof gives us more privacy from our neighbours who could see inside our conservatory from their upstairs windows"



FINISHING TOUCHES

The finishing touches to your SupaLite roof will add a great deal to the enjoyment you will have for years to come. Lighting and ventilation will pay a major part in the daily use of your conservatory so we offer the following finishes.

DAKEA ROOF VENTS

Roof lights and roof ventilation have been in popular use for the past 150 years. High quality materials and state of the art production techniques enable DAKEA to ensure excellent quality control and create durable, safe and functional roof windows that, together with their unrivalled insulation properties, are breaking new ground in roof window design and construction.

INSULATION

The FTT highly-energy efficient roof windows have been designed taking into account the stringent requirements of passive construction. This specialized and innovative design provides excellent performance by ensuring high efficiency of thermal energy.

INTERNAL LIGHTING

With a choice of internal lighting types to select from, we will provide you with the lighting of your choice which can be fitted in the ridge bulkhead or a newly installed lighting pelmet which will be plaster finished to match the interior of your roof as a whole.

EXTERNAL LIGHTING

The unique design of the SupaLite roof incorporates an external fascia and deep soffit. Many customers choose external LED's to be fitted into the soffit creating a feature that is both functional and aesthetically pleasing in the evenings. With long life and low running costs the external LED's can be left on all night in areas where security is needed.

All lighting is installed by fully qualified and insured NICEIC qualified electricians and will be covered with our business comprehensive warranty.

SECURITY

Secure window features a range of innovative solutions which makes it more burglary resistant. The window is fitted with laminated and burglary-resistant P2A glazing, new system preventing glazing removal and handle with a lock.

EXTERNAL FLASHINGS

Precisely designed flashing details ensure a durable and neat fit with the roofing material used. The purpose of flashing is to ensure good drainage away from the window and to provide protection from the elements. As there are many roofing materials available, DAKEA offers a range of flashing solutions.

All flashings are manufactured using aluminium as standard, permanently protected with a polyester varnish. The standard colour is brown RAL 7022, which match well with most roofing finishes.

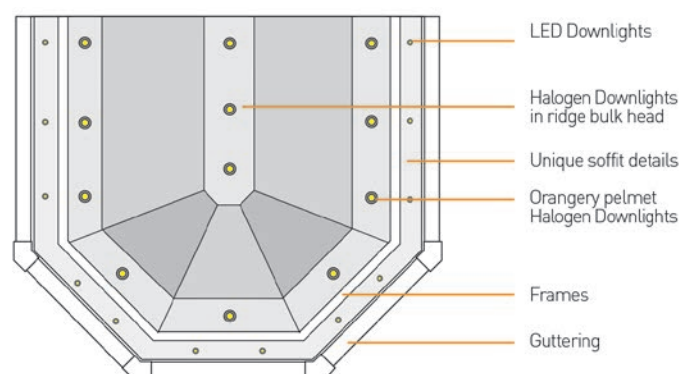
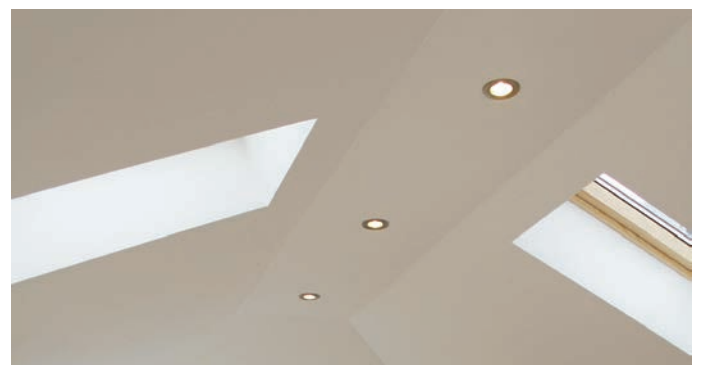

ROOF COVERINGS

EXTRALIGHT TILES

- ExtraLight tiles are up to 7 times lighter than traditional roofing materials;
- An ExtraLight lightweight roof places significantly less weight and stress on supporting structures and foundations;
- Lightweight tiles are more efficient to transport resulting in reduced cost and lower CO2 emissions;
- An ExtraLight roof generates no more noise than a roof built from traditional materials;
- ExtraLight tiles are tested to withstand the most extreme weather conditions;
- ExtraLight tiles can be used on pitches as low as 15°;
- Each tile is pressed from the highest drawing quality steel for unparalleled strength and higher performance;
- Every installation comes with a unique 50 year weatherproof guarantee;
- An ExtraLight roof needs virtually no maintenance once installed;
- All ExtraLight tiles meet British and European Standards;
- Each tile is 100% recyclable.



COMPOSITE SLATE

For centuries, slate roofing has been desired for its durability and beauty. With authentic surfaces and edges, our Composite Slate highlights the handsome character of slate, at the same time enhancing roof performance through innovative design. Unlike natural slate, Composite Slate won't break or de-laminate and comes with a Limited Lifetime Warranty.

Our Fire Rated Composite Slate gives you the power to evoke both historical elegance and outstanding modern-day style. Our slates are created with moulds cast from real slate to capture genuine peaks, plateaus and curves. Colour-through design and UV stabilisation ensure "stay-true" richness for traditional colours such as Black, Grey and Brown. A bold Red tone completes the selection.

Composite Slate Mixes are another feature of our unique colour choices, they deliver uncommon elegance through boldly-appealing multiple colours to turn your roof into a work of art.

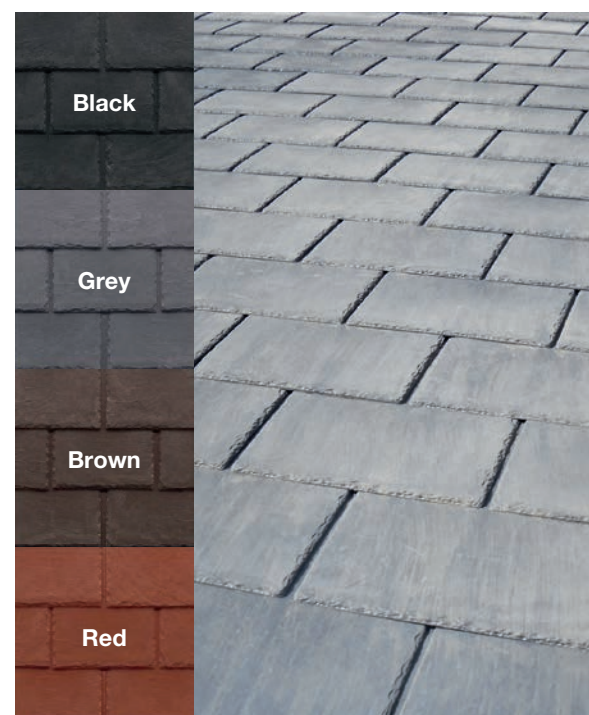



SUPALITE TILED ROOF SYSTEMS LTD

Administration, Distribution & Production Offices:

180 Bradkirk Place | Walton Summit | Preston | Lancashire | PR5 8AJ

Accounts & Marketing:

Unit 4 | Croft Street | Preston | Lancashire | PR1 8ST

Tel: **01772 82 80 60**

Fax: **01772 82 86 58**

Email: info@supaliteroof.co.uk

www.supaliteroof.co.uk